

**Manual**



**Central Vacuum  
System**

[www.sachvac.com](http://www.sachvac.com)



***Installation***



# CONTENTS

## INSTALLATION MANUAL

### HOW TO PLAN THE INSTALLATION?

1.	HOW DOES THE CENTRAL VACUUM SYSTEM WORK?	PAGE. 1
2.	WHAT ARE THE SPECIFIC CLEANING REQUIREMENTS OF THE HOUSE?	PAGE. 1
3.	HOW IS THE HOUSE CONSTRUCTED?	PAGE. 2
4.	HOW TO DETERMINE WHERE TO LOCATE THE CENTRAL VACUUM UNIT	PAGE. 2
5.	HOW TO DETERMINE WHERE TO LOCATE THE INLET VALVES	PAGE. 2
6.	HOW TO PLAN THE INSTALLATION OF THE PIPING NETWORK	PAGE. 3

### HOW TO INSTALL THE SYSTEM?

7.	TOOLS REQUIRED TO CARRY OUT THE INSTALLATION	PAGE. 4
8.	MATERIALS TO USE	PAGE. 5
9.	DOING THE INSTALLATION	PAGE. 6
9.1.	INSTALLATION OF THE PIPE NETWORK	PAGE. 6
9.2.	INSTALLATION OF THE MOUNTING PLATES AND INLET VALVES	PAGE. 7
9.3.	INSTALLATION OF THE LOW-VOLTAGE SIGNAL WIRE	PAGE. 8

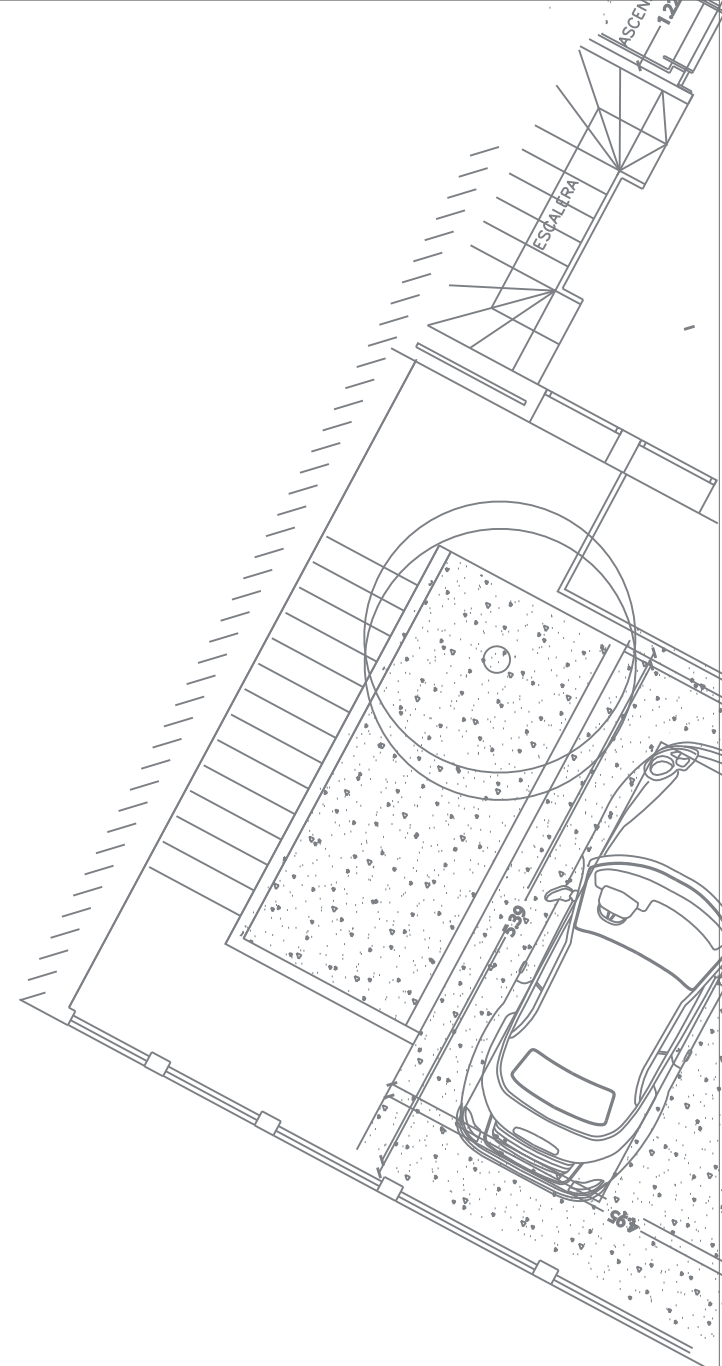

## HOW TO PLAN THE INSTALLATION?

A SACH central vacuum system is designed to improve your life quality over a long period of time. Read the instructions before beginning the installation. Be careful with the planning of the system. A few extra minutes of your time just now will ensure maximum effectiveness for your central vacuum system when you use it.

When planning a central vacuum system one of the key factors is designing the installation layout for the system. To achieve the right design the following 6 fundamental points need to be established:

- How does the central vacuum system work?
- What are the specific cleaning requirements of the house?
- How is the house constructed?
- How to determine where to locate the central vacuum unit.
- How to determine where to locate the inlet valves.
- How to plan the installation of the piping network.

### 1. How does the Central Vacuum System work?

The Central Vacuum Unit is located away from the living area, usually in the garage, junk-room, utility room, or boiler room. It is connected through a network of PVC pipe to inlet valves located strategically throughout the house. The central vacuum unit will automatically switch on thanks to a low-voltage electrical signal sent as a result of the 8 or 10 m hose being plugged into an inlet valve.

### 2. What are the specific cleaning requirements of the house?

Usually you would expect to be able to reach all areas of the house using a hose 8 or 10 metres long. With knowledge of the square metrage of the house you are able to estimate the number of inlet valves required, (as a rule 1 inlet valve per every 50 square metres of surface area.) To ensure maximum effectiveness for the system, however, the location of each inlet valve should be considered carefully.

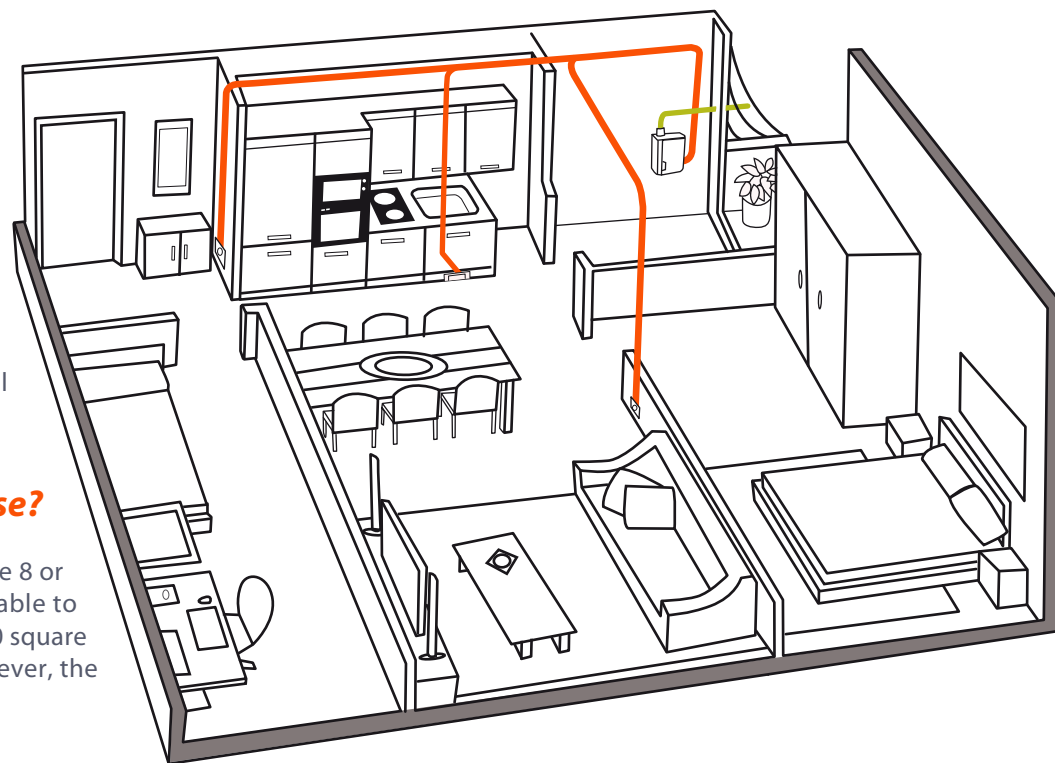

### 3. How is the house constructed?

The piping network usually runs through the floor, ceiling, walls, wardrobe, ventilation voids, chimney breasts, or in tandem with other supply networks. It is for this reason that it is necessary to know, for example, the house structure (columns, beams, etc), whether there is any other supply pipe-work which might interfere (central heating pipe-work, air conditioning); are there false ceilings or false beams and what is the width of internal and external walls?

### 4. How to determine where to locate the central vacuum unit.

The Central Vacuum Unit is located away from the living area, usually in the garage, junk-room, utility room, or boiler room or in a location where there is no equipment generating high temperatures. Avoid installing the central vacuum unit in an attic. A cupboard is a possible location provided that this is suitably ventilated. Although our central vacuum unit's filtration captures 99.97% of all dirt we recommend that the unit's exhaust is vented to the outside.

### 5. How to determine where to locate the inlet valves.

The inlet valves are usually installed in partition walls in hallways, near doors (never behind them), at the bottom of stairs (always vacuum from bottom to top). In this way you ensure the maximum coverage with a minimum number of inlet valves and you can often clean three or four rooms from one inlet valve. When positioning inlet valves the location of furniture needs to be given consideration.

When planning the location of the inlet valves use a length of cord, 8 - 10 metres long, to replicate the hose, in order to ensure that all areas of the home can be reached. Don't forget ceilings, wardrobes or any other possible furniture.

It is recommended that inlet valves are located in partition walls. If the walls are too narrow to accommodate the central vacuum pipe-work we can provide floor-mounted inlet valves.

For balconies, utility rooms and garages or for locations with visible pipe-work utility valves can be used which are easily connected to the net-work of piping.

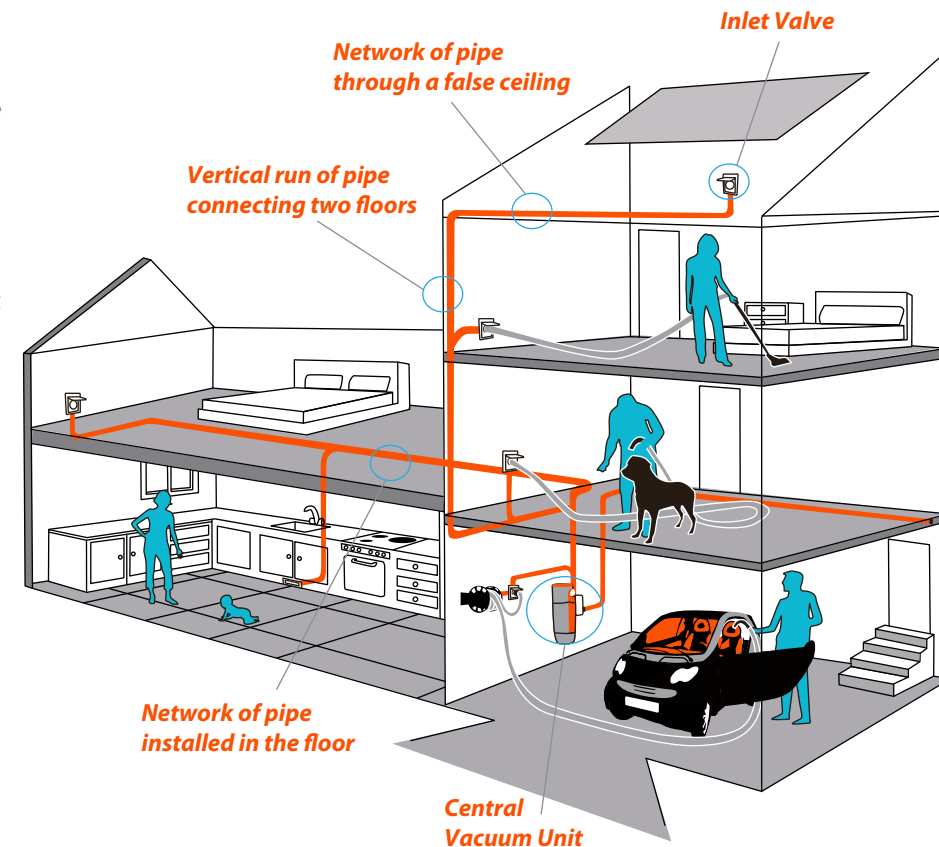

## 6. How to plan the piping network.

To ensure the most efficient layout of the piping network you should start with a main run of pipe from the most distant inlet valve to the central vacuum unit. From this you can branch off lengths of pipe to serve other inlet valves. There are several ways of achieving this:

- By connecting to inlet valves on the upper floor through the ground floor's false ceiling. To connect to valves on the ground floor pipe-work needs to run vertically inside the partition walls down to the height at which the valves are to be located.
- By connecting through the floor via a vertical pipe installed in a void (the back of a cupboard, service voids, ventilation shafts, chimney breasts, etc.) to different levels.
- Through the partition walls, false beams, etc...

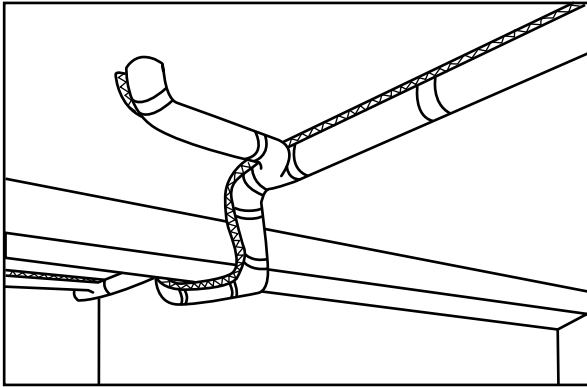

Check the path which the pipe-work is to follow to ensure there are no possible obstructions such as heating or water pipes which might require the re-location of an inlet valve.

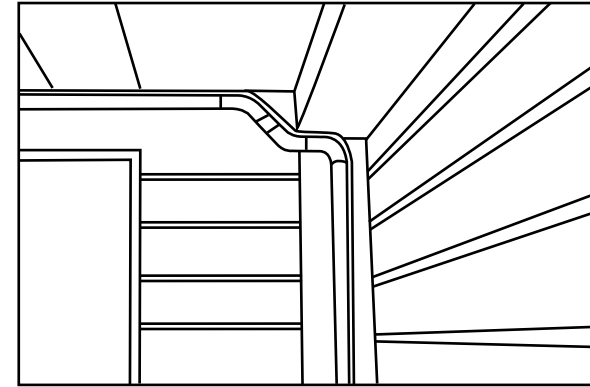

**IT IS ESSENTIAL THAT YOU ONLY USE INSTALLATION MATERIALS SPECIFICALLY DESIGNED FOR CENTRAL VACUUM INSTALLATIONS.**

SACH offers 51mm (2") pipe specifically for domestic central vacuum installations. Similarly, we also offer installation materials for larger commercial projects in 40, 50, 63, 80 and 100mm.

## HOW TO INSTALL THE SYSTEM?

The basic points to consider for the correct installation of a central vacuum system are:

- Tools required to carry out the installation.
- Materials to use.
- Doing the installation.

### 7. Tools required to carry out the installation

Below we list all the materials required to install a central vacuum unit correctly.

- **PIPE-CUTTER:** SACH, offers this useful tool which provides a perfect straight cut of the 51mm pipe specifically used for central vacuum installations.
- **METAL SAW:** This is also used for cutting PVC pipe. There are other tools which are more convenient for carrying out this task. (Ask SACH's Technical Department).
- **FILE:** This is required to ensure that the pipe cut is straight and smooth. (Very important!).
- **SCOURING PAD:** This is used to remove completely the residue which is left when the pipe is cut.
- **TAPE MEASURE.**
- **SPECIAL GLUE:** SACH offers its own glue specifically suited for working with PVC. The tub is supplied with a spatula for easy application.
- **CLOTH:** Always necessary to wipe off excess glue.
- **DRILL WITH HAMMER SETTING:** This is required for putting rawlplugs in partition walls and concrete beams for attaching pipe.
- **SLOTTED AND PHILIPS SCREWDRIVERS:** These are required for attaching the pipe straps that secure the pipe-work, positioning covers and inlet valves, etc...
- **HEAVY-DUTY SCISSORS:** These are required for cutting the electrical conduit that runs parallel to the pipe network.
- **WIRE CRIMPERS:** These are required for securing the low-voltage wire in the electrical box and to the inlet valves.

## 8. Fittings

Below we list all types of material required for a correct installation of 51mm diameter pipe for a domestic central vacuum installation:

	<p><b>PVC Pipe</b></p> <p>51mm Ø x 1.6mm thick wall.</p>		<p><b>Inlet Valve</b></p> <p>Allows you to connect the hose to the central vacuum system.</p>		<p><b>45° Double Wye</b></p> <p>Allows for a bifurcation of the pipe network.</p>		<p><b>Slip Coupling</b></p> <p>Used for connecting two lengths of pipe.</p>
	<p><b>45° F-F Elbow</b></p> <p>Used to make 90° or 180° turns in the pipe. There needs to be a perfect fit between elbow and pipe with no residual PVC at the pipe cut.</p>		<p><b>Electrical Conduit</b></p> <p>1.5mm thick x 2m long</p> <p>Transmits the signal from the inlet valve which switches on the central vacuum unit.</p>		<p><b>45° Single Wye</b></p> <p>This fitting allows us to branch off from the main line. The direction of air-flow must always be taken into account.</p>		<p><b>M-M or F-F Stop Coupling</b></p> <p>Used to connect two lengths of pipe.</p>
	<p><b>45° M-F Elbow</b></p> <p>Used in conjunction with a 45° F-F Elbow this fitting permits you to make a tighter 90° bend than by using two 45° F-F Elbows.</p>		<p><b>Inlet Valve Mounting Plate</b></p> <p>Embedded in the partition wall it connects to the inlet valve and provides the starting point for the network of piping</p>		<p><b>PVC Glue</b></p> <p>Used for gluing the fittings to the pipe. It should only be applied to the male extremities of the fitting or pipe.</p>		<p><b>Slip Cap</b></p> <p>Used to prevent dampness getting into the pipe network.</p>
	<p><b>F-F 90° Sweep Elbow</b></p> <p>This fitting's broad bend makes it suited to all types of central vacuum installations</p>		<p><b>Cable Ties</b></p> <p>These are used for securing the electrical conduit to the pipe.</p>		<p><b>F-F 90° Sweep Tee</b></p> <p>This fitting allows us to branch off from the main line. The direction of air-flow must always be taken into account.</p>		<p><b>F-F-90° Short Elbow</b></p> <p>Positioned directly behind the mounting plate and is used to prevent objects entering the system or to execute tight curves when manoeuvring pipe around obstacles</p>

## 9. Doing the installation

The different stages of a central vacuum system installation are:

- Installation of the pipe network.
- Installation of the electrical lines.
- Installation of the mounting plates and inlet valves.

### 9.1. Installation of the pipe network

The system network comprises 51mm (2") diameter PVC pipe and low-voltage electrical wire which provides the operational signal for the central vacuum unit from the inlet valves. When installing, one of the key points to bear in mind is the direction of air-flow. Once we've established the directional air-flow (from the inlet valves to the central vacuum unit) we can plan the location of the elbows and other fittings.

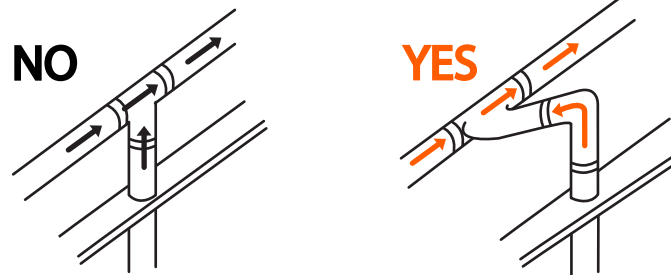

All the twists and turns that the network might require will be achieved with 45° elbows, 45° single wyes, 90° sweep elbows or sweep tees.

Connections to a horizontal line of pipe should always be from the side or from above, never from below!

It is important to ensure the maximum possible air circulation within the pipe network. For this we must take into consideration the following:



The PVC pipe cut should be completely straight to ensure that it fits perfectly inside the elbow. Avoid any unnecessary bends or deviations.



The inside of the pipe needs to be perfectly smooth (use a file and if necessary a scouring pad) to ensure there is no residual PVC inside the pipe for fluff to catch on.

Before applying the glue it is necessary to clean the pipe and the interior of the fitting with a liquid solvent. The glue or liquid solder should only be applied to the male extremities of the parts to be glued together. Normally this will be the outside of the pipe or, in the event of it having a male connection, the fitting itself.

## 9.2. Installation of the mounting plates and inlet valves

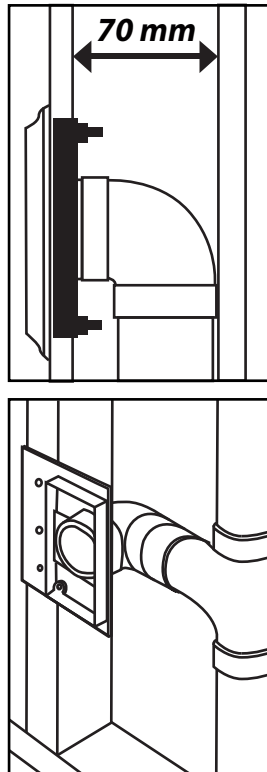

There are two types of mounting plates: a straight mounting plate and a curved mounting plate with elbow. The curved mounting plate is used when the pipe is built into a partition wall (half inch thick breeze block or plaster). Where the situation permits, it is always recommended to use the curved mounting plate because it is able to accommodate a shorter 90° elbow, which prevents objects entering the system.

Both types of mounting plates are built into the wall. The curved mounting plate only requires a width of 7cm. Alternatively, if the partition wall is not sufficiently thick to accommodate this width, cupboard recesses, ducting, false columns or external walls can be used.

Once the walls have been plastered the mounting plates should remain flush with these and not protrude from the wall.

### 9.3. Installation of the low-voltage electrical line

Where possible the inlet valve can be used as the junction box. If this is not practical you need to create junction boxes similar to those used in other electrical installations.

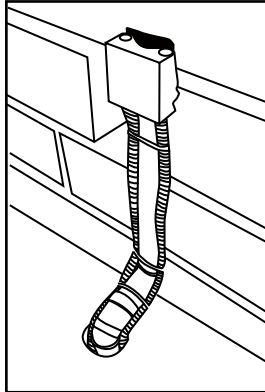
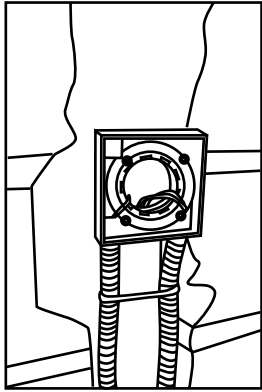

The low-voltage cabling runs parallel to the ducting and is housed in electrical conduit.

The low-voltage electrical line which provides the electrical signal from each individual inlet valve which switches the central vacuum unit on, is attached to the PVC pipe.

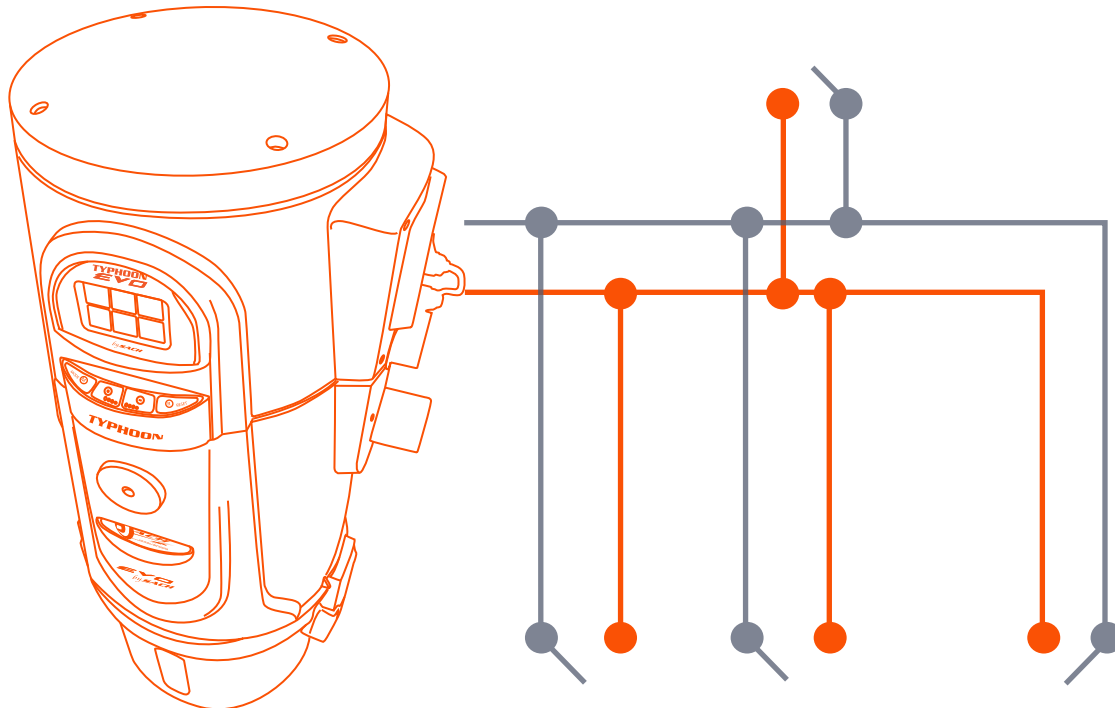



**Central Vacuum  
Systems**

C/VEREDA DE LOS BARROS,67 NAVE A-B  
POL.IND.VENTORRO DEL CANO  
28925-ALCORCÓN-MADRID-SPAIN  
TEL.+34 91 633 34 93  
FAX.+34 91 633 49 31

**COSTUMER SERVICE**  
**+34 902 088 066**